

VIC

234

1

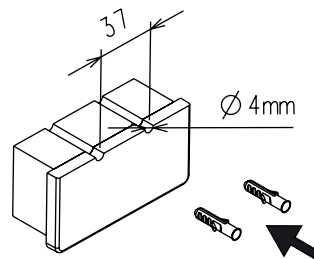
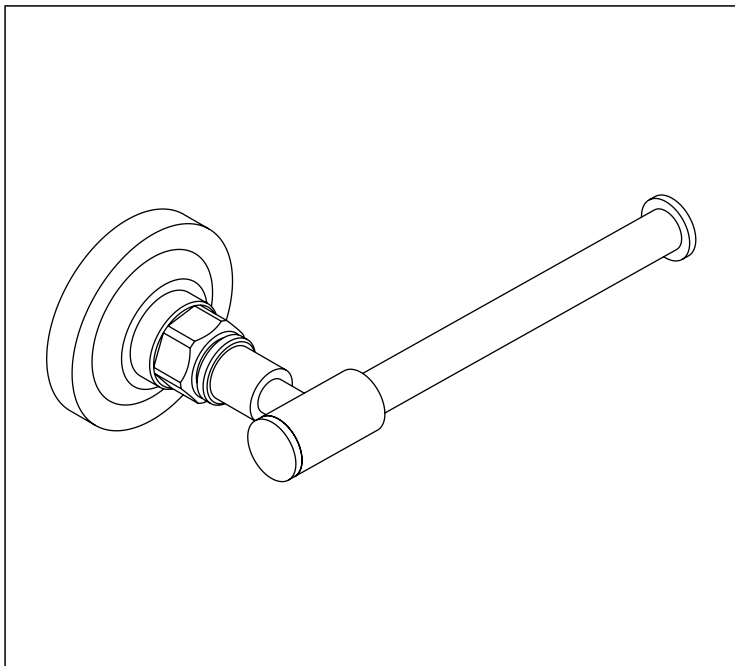

2

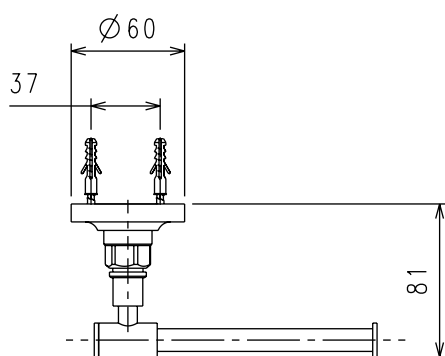
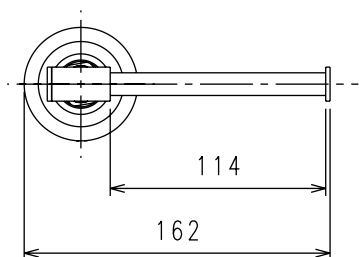
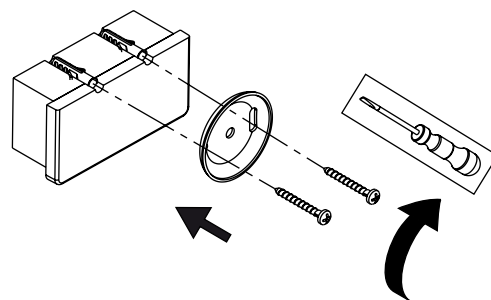

3

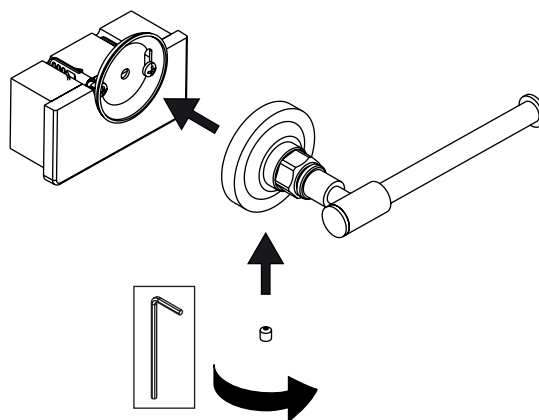

SMALTIMENTO DEL PRODOTTO >

NON DISPERDERE NELL' AMBIENTE PER IL CORRETTO SMALTIMENTO DEL PRODOTTO, FARE RIFERIMENTO ALLA NORMATIVA VIGENTE NEL PAESE IN CUI SI VIVE. CONTATTARE LA DISCARICA PIU' VICINA PER MAGGIORI INFORMAZIONI.

DISPOSAL OF THE ITEM >

NOT DISPERSE IN NATURE FOR A CORRECT DISPOSAL OF THE ITEM, PLEASE REFER TO THE SPECIFIC RULES OF YOUR COUNTRY. THE APPOINTED OFFICE IN YOUR AREA FOR DETAILS.

> MONTAGGIO, USO E MANUTENZIONE - LEGGERE ATTENTAMENTE PRIMA DELL'INSTALLAZIONE - CONSERVARE

> ASSEMBLY, USE AND MAINTENANCE INSTRUCTIONS - READ CAREFULLY BEFORE INSTALLING - TO PRESERVE