

3045

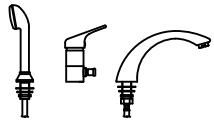

5048

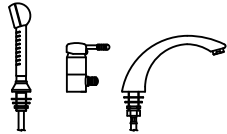

7045

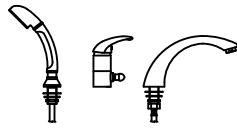

8045

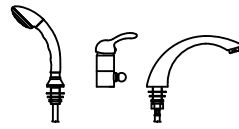

10045

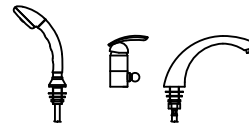

12045

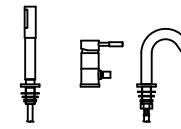

31045

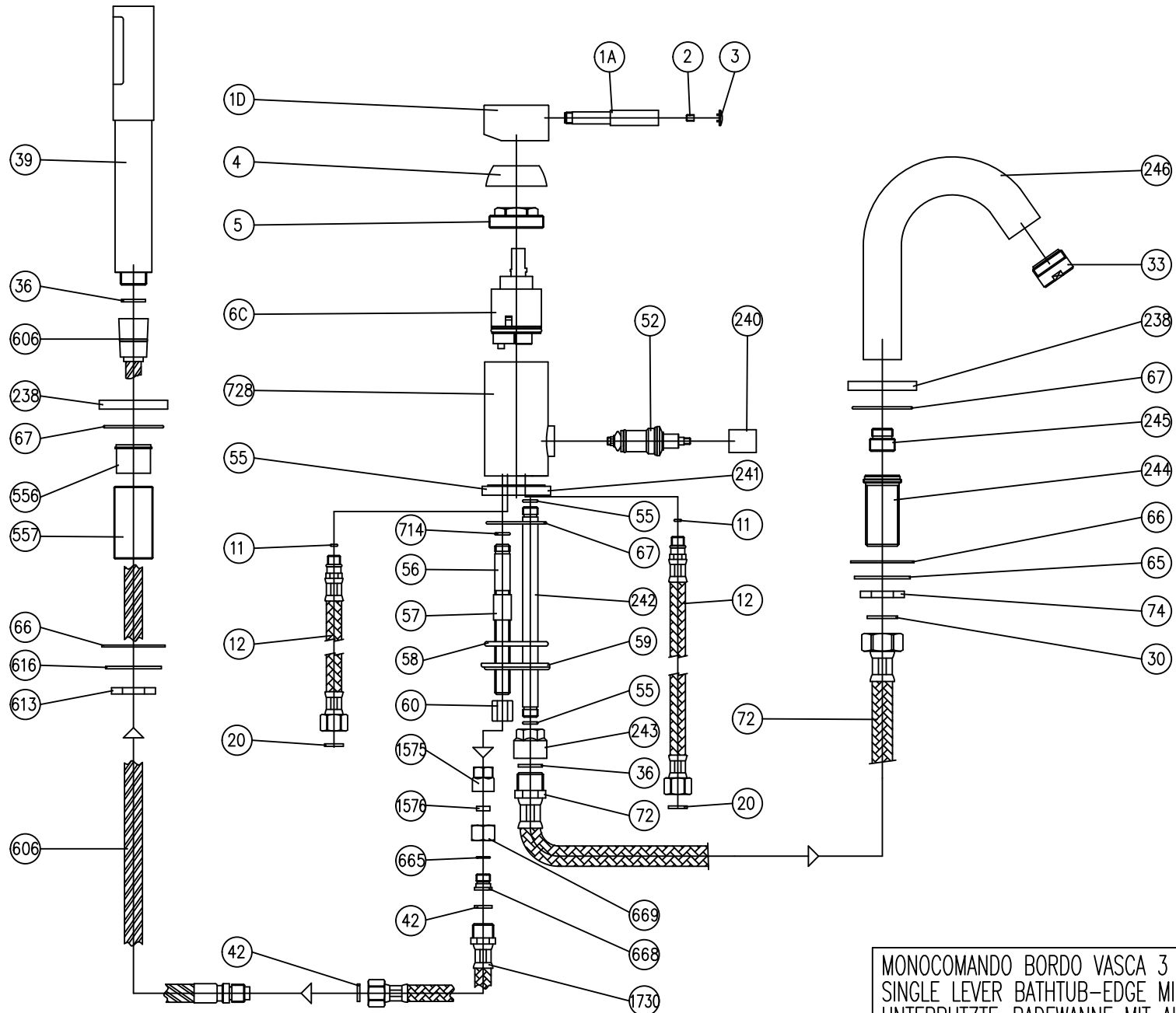
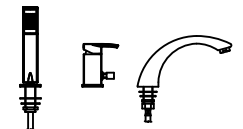

MONOCOMANDO BORDO VASCA 3 FORI
 SINGLE LEVER BATHTUB-EDGE MIXER
 UNTERPUTZTE-BADEWANNE MIT AUTOMATISCHEN ABLENKER

ISTRUZIONI PER IL MONTAGGIO NUOVO BORDO
VASCA CON PORTATA ACQUA MODIFICATA

- 1- PRIMA DI FISSARE IL RUBINETTO ALLA VASCA
BISOGNA COLLEGARE AL CORPO CENTRALE I
DUE FLEX INOX PER L'ACQUA FREDDA E CALDA,
IL TIRANTE "D" PER IL FISSAGGIO ED IL TIRANTE
"E" PER IL COLLEGAMENTO ALLA BOCCA DI
EROGAZIONE
- 2- SI CONSIGLIA DI PRATICARE UN FORO
DI DIAMETRO 40 mm SULLA VASCA PER
FISSARE IL CORPO CENTRALE
- 3- EFFETTUATI I COLLEGAMENTI SI PUO'
PROCEDERE AL FISSAGGIO SULLA VASCA

INSTRUCTIONS FOR THE INSTALLATION
OF BATH RIM MIXER

- 1- BEFORE INSTALLING THE MIXING UNIT
ON THE RIM, SCREW UP THE HOT/COLD
WATER CONNECTIONS, ALSO THE FIXING
ROD "D" AND THE ROD "E" CONNECTING
TO THE SPOUT MUST BE CONNECTED TO
THE BODY OF TAP BEFORE INSTALLATION
- 2- WE SUGGEST TO MAKE A HOLE OF
DIAMETER 40 MM FOR THE INSTALLATION
OF THE MIXING UNIT

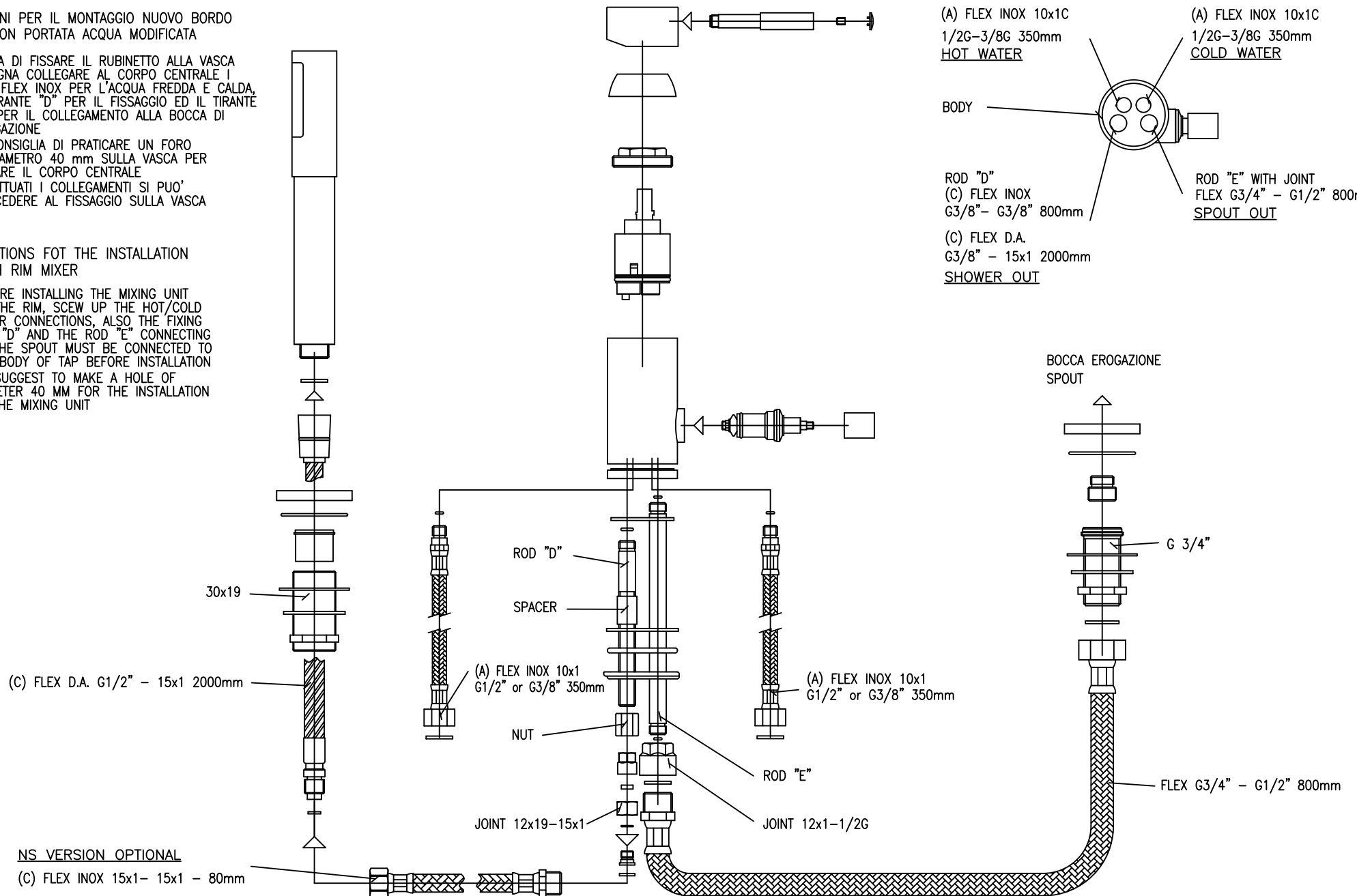

MONOCOMANDO BORDO VASCA 3 FORI
SINGLE LEVER BATHTUB-EDGE MIXER
UNTERPUTZTE-BADEWANNE MIT AUTOMATISCHEN ABLENKER

ISTRUZIONI DI MONTAGGIO ASSEMBLIG INSTRUCTION

I: Se si installa il gruppo su vasche da bagno con spessore maggiore di 27mm: l'utilizzo del particolari 1 è facoltativo.

Per vasche da bagno con spessore minore di 27mm: utilizzare il particolare 1 nella posizione indicata

UK: If the mixer is installed on bathtub thicker than 27mm: components 1 is optional.

For bathtub with thickness minor than 27mm: use item 1 in the correct position

При установке смесителя на ванну с толщиной стенки менее 27mm используйте дополнительно детали поз. 1.

При установке смесителя на ванну с толщиной стенки более 27mm использование деталей поз. 1 не требуется.

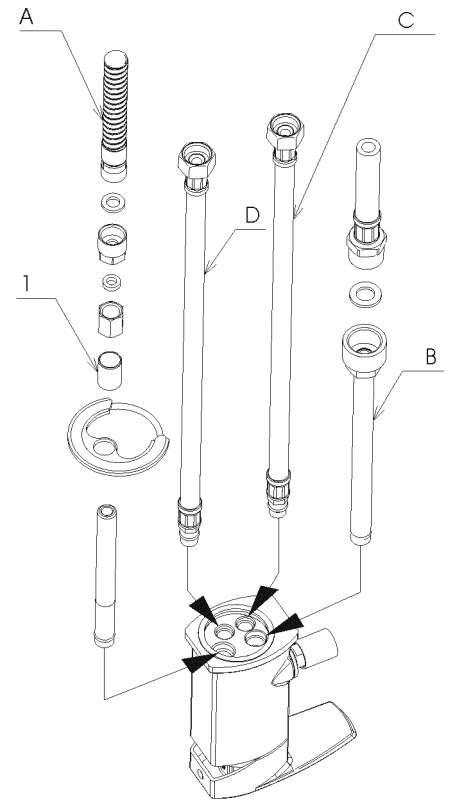
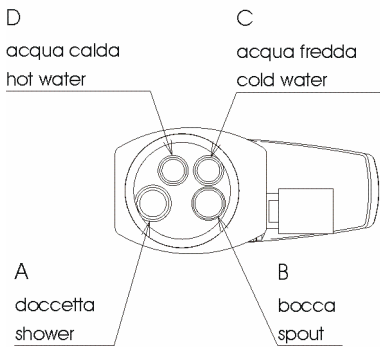

ISTRUZIONI DI MONTAGGIO ASSEMBLIG INSTRUCTION

I: Se si installa il gruppo su vasche da bagno con spessore maggiore di 27mm: l'utilizzo del particolari 1 è facoltativo.

Per vasche da bagno con spessore minore di 27mm: utilizzare il particolare 1 nella posizione indicata

UK: If the mixer is installed on bathtub thicker than 27mm: components 1 is optional.

For bathtub with thickness minor than 27mm: use item 1 in the correct position

При установке смесителя на ванну с толщиной стенки менее 27mm используйте дополнительно детали поз. 1.

При установке смесителя на ванну с толщиной стенки более 27mm использование деталей поз. 1 не требуется.

